

Weichendecoder für Doppelkreuzungsweiche 12,1°

74467

Inhaltsverzeichnis	Seite	Sommaire	Page
Bestimmungsgemäße Verwendung	4	Usage conforme	10
Lieferumfang	4	Matériel fourni	10
Sicherheitshinweise	4	Consignes de sécurité	10
Wichtige Hinweise	4	Indications importantes	10
Technische Daten	4	Caractéristiques techniques	10
Funktionen	4	Fonctions	10
Decoder-Einbau	5/28	Installation du décodeur	11/28
CV Programmierung	5	Programmation des CV	11
Betrieb unter mfx	6	Exploitation sous mfx	12
Alternative Stromversorgung	30/32	Alimentation en courant alternative	30/32
Programmier-Tabellen	34	Tableau de programmation	34

Table of Contents	Page	Inhoudsopgave	Pagina
Normal Use	7	Beoogd gebruik	13
Contents as Delivered	7	Leveringsomvang	13
Safety Notes	7	Veiligheidsvoorschriften	13
Important Information	7	Belangrijke aanwijzingen	13
Technical Data	7	Technische gegevens	13
Functions	7	Werking	13
Decoder Installation	8/28	Decoder inbouwen	14/28
CV Programming	8	CV-programmering	14
Operation with mfx	9	Bedrijf met mfx	15
Alternative Power Supply	30/32	Alternatieve stroomvoorziening	30/32
Programming Table	34	Programmeertabel	34

Índice	Página	Innehållsförteckning	Sidan
Uso previsto	16	Användningsområde	22
Alcance de suministro	16	Ingående material vid leverans	22
Instrucciones de seguridad	16	Säkerhetsanvisningar	22
Notas importantes	16	Viktig information	22
Datos técnicos	16	Tekniska data	22
Funciones	16	Funktioner	22
Montaje del decoder	17/28	Inbyggnad av dekodern	23/28
Programación de variables CV	17	CV programmering	23
Funcionamiento en modo mfx	18	Körning med mfx	24
Alimentazione di corrente alternativa	30/32	Alternativ strömförsörjning	30/32
Tabla de programación	34	Programmeringstabell	34

Elenco del contenuto	Pagina	Indholdsfortegnelse	Side
Impiego commisurato alla destinazione	19	Hensigtsmæssig anvendelse	25
Corredo di forniture	19	Leveringsomfang	25
Avvertenze di sicurezza	19	Sikkerhedsbemærkninger	25
Avvertenze importanti	19	Vigtige bemærkninger	25
Dati tecnici	19	Tekniske data	25
Funzioni	19	Funktioner	25
Montaggio del Decoder	20/28	Indbygning af dekode	26/28
Programmazione delle CV	20	CV programmering	26
Esercizio sotto mfx	21	Drift med mfx	27
Alimentación eléctrica	30/32	Alternativ strømforsyning	30/32
Tabella di programmazione	34	Programmeringstabel	34

Bestimmungsgemäße Verwendung

- Decoder zum Einbau in die Märklin Doppelkreuzungsweiche (DKW) 24720 oder die Trix DKW 62720.
- Der Einbau-Digital-Decoder darf bei externer Stromversorgung nur an Märklin- bzw. Trix-Schaltnetzteile angeschlossen werden.
- Darf nur in trockenen Räumen verwendet werden.
- Der Decoder darf nicht mit analogem Fahrstrom betrieben werden.

Lieferumfang

- 1 Einbau-Digital-Decoder
- 1 Kabel gelb, rot und braun (C-Gleis Märklin)
- 1 Kabel blau, rot und weiß (C-Gleis Trix)
- Einbauanleitung
- Garantiekunde

Sicherheitshinweise

- **ACHTUNG!** Funktionsbedingte scharfe Kanten und Spitzen.
- Verkabelungs- und Montagearbeiten nur im spannungslosen Zustand ausführen. Bei Nichtbeachtung kann es zu gefährlichen Körperströmen und damit zu Verletzungen führen.
- **Decoder nur mit der zulässigen Spannung** (siehe technische Daten) **betreiben**.

Wichtige Hinweise

- **Achtung:** Beim Einbau möglichst keine Bauteile auf der Oberseite des Einbau-Digital-Decoders berühren, statische Aufladung kann die Funktion beeinträchtigen.
- Die Bedienungsanleitung ist Bestandteil des Produktes und muss deshalb aufbewahrt sowie bei Weitergabe des Produk-

tes mitgegeben werden.

- Für Reparaturen wenden Sie sich bitte an Ihren Märklin-Fachhändler.
- <http://www.maerklin.com/en/imprint.html>

Technische Daten

- Belastung Laternenausgang ≤ 100 mA
- Belastung Weichenausgang max. 2 A
- Spannung Digitalstromkreis max. 20 V eff.
- Spannung extern max. 20 V DC
- Spannungsfestigkeit max. 40 V

Funktionen

- Multiprotokoll fähig: fx (MM), mfx* und DCC
- Einstellen der Betriebsart mittels DIP-Schalter, siehe Seite 34
- Einstellbare Adressen mit DIP-Schalter:
1-256 fx (MM) (Control Unit 6021 / Central Station 1)
1-320 fx (MM) (Central Station 2/3 / Mobile Station 2)
1-511 (DCC)
- Programmierbare Adressen über CV **1 – 2.044** DCC
- gültig ist die **jeweils letzte** Adresseinstellung, egal ob über Programmierung oder über DIP-Schalter
- Änderungen der Eigenschaften über CV
- Digitalsignal: Übertragung unabhängig von der Stromversorgung
- Stromversorgung über Digitalstromkreis
- Alternative Stromversorgung
- Löt pads für Anschluss der Weichenlaterne
- Weichenlaterne aus- oder einschaltbar

* mfx erst ab CS 2 Softwareversion 4.0

Decoder-Einbau

Folgende Arbeitsschritte dürfen nur im spannungslosen Zustand ausgeführt werden:

- Stecken Sie das mitgelieferte Kabel in die dafür vorgesehene Buchse, siehe Seite 28. Folgen Sie nun der bebilderten Anleitung.

Änderungen der anderen Eigenschaften im fx (MM)-Protokoll durch CV-Programmierung oder zur DCC CV-Programmierung folgen Sie dem Kapitel „CV Programmierung“.

Beachten Sie: Einstellungen mit dem DIP-Schalter immer spannungslos vornehmen. Der Einbau-Digital-Decoder erkennt erst mit dem Einschalten der Spannung die aktuellen Schalterstellungen.

CV Programmierung

Die CV Programmierung muss am Programmiergleis erfolgen. Für die Programmierung empfehlen wir, ist eine Lokomotive manuell anzulegen. Werte in Klammern sind die Werkseinstellungen.

Während der Datenübertragung blinkt zur Kontrolle die am Einbau-Digital-Decoder angeschlossene Weichenlaterne.

Die Programmierung kann wahlweise über fx (MM) oder DCC erfolgen. Die Einstellung der Adresse empfehlen wir bei fx (MM) mittels DIP-Schalter (siehe 34 ff) durchzuführen.

fx (MM)

Vor der Programmierung muss die zu programmierende Weiche mit dem Keyboard geschaltet werden. Danach unverzüglich mit der Control Unit bzw. CV Konfiguration der Central Station die CV ändern. Sofort danach die neu programmierte Weiche wieder mit dem Keyboard schalten. Erst jetzt ist die Programmierung übernommen und wirksam.

CV	Bedeutung	Werte	
8	Decoder-Reset	8 (-)	Werkseinstellung, Wert wird nicht geschrieben
36	Weichenlaterne aus/ein	0-1 (1)	kann nur während der Programmierung festgelegt werden.

Die Vorgehensweise beim Programmieren mit der Control Unit 6021 entspricht der Lokprogrammierung (www.maerklin.de -> Service -> Technische Informationen).

DCC



CV	Bedeutung	Werte	
1	Adresse, niederwertige Byte	0-255 (1)	
7	Hersteller Versionsnummer (Softwareversion)	(-)	nur lesen
8	Hersteller Kennung ID Decoder Reset	(131) 8 (-)	nur lesen, Werkseinstellung, Wert wird nicht geschrieben
9	Adresse, höherwertige Byte	0-7 (0)	
29	Konfiguration	(192)	nur lesen
	Bit 0-4 werden nicht verwendet	0	
	Bit 5: Decodertyp	0 / 32	Basis- o. erweiterter Zubehördecoder
	Bit 6: Adressierungsmethode	0 / 64	Decoder- o. Ausgangsadresse
	Bit 7: Decoderart	128	Zubehördecoder
36	Weichenlaterne, aus/ein	0-1 (1)	

Einstellen und errechnen der Adressen größer 255:

Z.B. Adresse 1044 -> $1044:256=4,078125$. Der Wert vor dem Komma (4) ist in CV 9 einzutragen. Den Wert nach dem Komma (0,078125) wird mit 256 multipliziert $0,078125 \times 256=20$. Der errechnete Wert 20 muss in CV 1 eingetragen werden.

Betrieb unter mfx

Die mfx-Anmeldung kann unter MM oder DCC erfolgen. Entscheidend ist die über den Dip-Schalter 10 eingestellte Betriebsart.

Die mfx-Anmeldung wird mit der CS2 60213/60214/60215 in der Magnetartikelkonfiguration über  >  und mit der CS3 60216/60226 in der Magnetartikelkonfiguration über  > „mfx-Artikel suchen“ angestoßen.

Hinweis zur mfx-Anmeldung mit der CS2:

Auswahlmöglichkeit „Magnetartikel automatisch zuweisen“ unter „Setup“ >  > „Gleis“.

Ist dort das Häkchen gesetzt erfolgt die mfx-Anmeldung auf die ersten freien Adressen in der CS2. Ist das Häkchen nicht gesetzt, erfolgt die mfx-Anmeldung auf die tatsächlich am Decoder programmierten Adressen.

Normal Use

- Decoder for installation in the Märklin 24720 double slip switch (DKW) or the Trix 62720 DKW.
- This digital installation decoder may only be connected to Märklin or Trix switched mode power packs for external power supply.
- This decoder may only be used in dry areas indoors.
- This decoder may not be operated with analog train operating current.

Contents as Delivered

- 1 digital installation decoder
- 1 cable – yellow, red, and brown (for Märklin C Track)
- 1 cable – blue, red, and white (for Trix C Track)
- Installation instructions
- Warranty card

Safety Notes

- **IMPORTANT!** This product has sharp edges and points related to its function.
- Do wiring and assembly work only in a voltage-free work environment. Otherwise you may experience electrical current dangerous to the body leading to injury.
- **Operate this decoder only with the permissible voltage** (see technical information).

Important Information

- **Important:** When installing the digital installation decoder, try to avoid touching components on the upper side of the decoder. Static charge can affect the function of the decoder.
- The operating instructions are a component part of the product and must therefore be kept with the product, particularly when it is given to another party.
- For repairs please see your authorized Märklin specialty dealer.
- <http://www.maerklin.com/en/imprint.html>

Technical Data

- Load at lantern output ≤ 100 milliamps
- Load at turnout output max. 2 amps
- Voltage for the digital power circuit max. 20 volts eff.
- External voltage max. 20 volts DC
- Electrical strength max. 40 volts

Functions

- Capable of multi-protocols: fx (MM), mfx* and DCC
- Setting the mode of operation by means of DIP switches, see Page 34
- Addresses can be set with DIP switches:
1-256 fx (MM) (Control Unit 6021 / Central Station 1)
1-320 fx (MM) (Central Station 2/3 / Mobile Station 2)
1-511 (DCC) edit
- Programmable addresses using CVs
1-2,044 DCC
- **The last** respective address setting is valid, regardless of whether it was done with programming or with the DIP switches

* mfx not until CS 2 Software Version 4.0

- Changes to characteristics can be done with CVs
- Digital signal: transfer independent of the power supply
- Power supply done using the digital power circuit
- Alternative power supply
- Solder pads for connections for turnout lanterns
- Turnout lanterns can be turned on or off

Decoder Installation

The following work steps may only be done in a voltage-free work environment:

- Plug the cable included with the decoder in the socket provided for it – see page 28. Now follow the illustrated instructions.

See the section “CV Programming” for changes to other characteristics in the fx (MM) protocol using CV programming or to the DCC CV programming.

Note: Settings with the DIP switches are to be only when the voltage is turned off. The digital installation decoder does not recognize the current switch settings until the voltage is turned on. Starting on page 39 you'll find the table for setting addresses with DIP switches.

CV Programming

CV programming must be done on the programming track. We recommend creating a fictitious locomotive for programming purposes. Values in parentheses are the factory settings. The turnout lantern connected to the digital installation decoder will blink as a control check during the data transmission. The programming can be done optionally with fx (MM) or DCC. In fx (MM), we recommend setting the address by means of DIP switches (see 34 ff).

fx (MM)

Before doing any programming, the turnout to be programmed must be switched with the Keyboard. After that the CVs are changed immediately with the Control Unit or the CV configuration on the Central Station. Immediately after that, switch the newly programmed turnout again with the Keyboard. At this point the programming is accepted and is functional.

CV	Meaning	Values	
8	Decoder reset	8 (-)	factory setting, not written value is
36	Turnout lantern off/on	0-1 (1)	can only be set during programming

The procedure for programming with the 6021 Control Unit is the same as locomotive programming (www.maerklin.de -> Service -> Technische Informationen).



DCC

CV	Meaning	Values	
1	Address, lower value Byte	0-255 (1)	
7	Manufacturer version number (software version)	(-)	read only
8	Manufacture recognition ID Decoder reset	(131) 8 (-)	read only, factory setting, value is not written
9	Address, higher value Byte	0-7 (0)	
29	Configuration	(192)	read only
	Bits 0-4 are not used	0	
	Bit 5: Decoder type	0 / 32	basic or advanced accessory decoder
	Bit 6: Addressing method	0 / 64	decoder or output address
	Bit 7: Decoder type	128	accessory decoder
36	Turnout lantern, off/on	0-1 (1)	

Setting and generating addresses larger than 255:

Example: Address 1044 -> 1044:256=4,078125 . The value before the comma (4) is to be entered in CV 9. The value after the comma (0,078125) is multiplied by 256, 078125x256=20. The value of 20 that is generated must be entered in CV 1.

Operation with mfx

mfx registration can be done with MM or DCC. The mode of operation that has been set by means of Dip Switch 10 is critical. The mfx registration is initiated with the 60213/60214/60215 CS2 in  >  and with the 60216/60226 CS3 in the solenoid item configuration by means of  > "search for mfx item".

Note about mfx registration with the CS2:

Selection possibility „Automatically assign solenoid item“ at „Setup“ >  > „Track“.

If the check mark there is checked, the mfx registration is done at the first open address in the CS2. If the check mark is not checked, the mfx registration is done at the address actually programmed on the decoder.

Usage conforme

- Décodeur pour installation dans la traversée-jonction double (TJD) Märklin réf. 24720 ou Trix réf. 62720.
- Dans le cas d'une alimentation en courant externe, ce décodeur numérique peut être raccordé uniquement à un convertisseur continu-continu Märklin ou Trix.
- A utiliser exclusivement dans des pièces sèches.
- Le décodeur ne doit pas être exploité avec du courant traction analogique.

Matériel fourni

- 1 Décodeur numérique à installer
- 1 câble de chaque couleur suivante : jaune, rouge et marron (voie C Märklin)
- 1 câble de chaque couleur suivante : bleu, rouge et blanc (voie C Trix)
- Notice d'installation
- Bon de garantie

Consignes de sécurité

- **ATTENTION !** L'appareil présente des arêtes coupantes.
- Câblage et montage doivent être réalisés uniquement quand l'appareil est hors tension. Le non respect de ces consignes peut générer des courants de choc dangereux et être à l'origine de blessures.
- **Exploiter le décodeur uniquement avec la tension autorisée** (voir caractéristiques techniques).

Indications importantes

- **Attention :** Lors de l'installation, éviter dans la mesure du possible de toucher les composants situés sur la face supérieure du décodeur numérique, une charge statique pouvant entraver le fonctionnement.
- La notice d'utilisation fait partie intégrante du produit ; elle doit donc être conservée et, le cas échéant, transmise avec le produit.
- Pour toute réparation, adressez-vous SVP à votre détaillant spécialisé Märklin.
- <http://www.maerklin.com/en/imprint.html>

Caractéristiques techniques

- | | |
|-----------------------------|----------------|
| • Charge sortie lanterne | ≤ 100 mA |
| • Charge sortie aiguille | max. 2 A |
| • Tension circuit numérique | max. 20 V eff. |
| • Tension externe | max. 20 V c.c. |
| • Tenue en tension | max. 40V |

Fonctions

- multi protocole: fx (MM), mfx* et DCC
- Définition du mode d'exploitation via commutateur DIP, voir page 34
- Définition des adresses possible via commutateur DIP :
1-256 fx (MM) (Control Unit 6021 / Central Station 1)
1-320 fx (MM) (Central Station 2/3 / Mobile Station 2)
1-511 (DCC)
- Adresses programmables via CV
1-2044 DCC
- C'est **toujours la dernière** adresse enregistrée qui prévaut,

* mfx à partir de la version logicielle CS 2.4.0

- qu'elle ait été programmée ou définie via commutateur DIP
- Modifications des propriétés via CV
- Signal numérique : Transmission indépendante de l'alimentation en courant
- Alimentation en courant via circuit numérique
- Alimentation en courant alternative
- Plages d'accueil pour raccordement de la lanterne d'aiguille
- Lanterne d'aiguille commutable

Installation du décodeur

L'installation, dont les différentes étapes sont décrites ci-dessous, doit impérativement être réalisée hors tension :

- Enfichez le câble fourni dans la prise prévue à cet effet, voir page 28. Suivez alors la notice illustrée.

Pour modifier les autres caractéristiques dans le protocole fx (MM) via la programmation des CV ou pour la programmation des CV dans le protocole DCC, veuillez suivre les indications du chapitre « Programmation des CV ».

Attention : Les paramétrages avec le commutateur DIP doivent toujours se faire hors tension. Le décodeur numérique ne reconnaît les nouvelles positions du commutateur qu'à la mise sous tension.

Programmation des CV

La programmation des CV se fait sur la voie de programmation. Pour la programmation, nous vous conseillons de créer une locomotive fictive. Les valeurs indiquées entre parenthèses correspondent aux paramètres d'usine.

Durant la transmission des données, la lanterne d'aiguille raccordée au décodeur numérique clignote (contrôle).

La programmation peut se faire au choix via fx (MM) ou DCC. Pour fx (MM), nous conseillons de définir l'adresse via commutateur DIP (voir page 34 et suivantes).

fx (MM)

Avant de procéder à la programmation, commutez l'aiguille à programmer via le Keyboard. Modifiez ensuite sans attendre la CV avec la Control Unit, respectivement via la fonction de configuration des CV de la Central Station. Commutez alors à nouveau et immédiatement l'aiguille programmée via le Keyboard. La programmation est enfin enregistrée et effective.

CV	Signification	Valeurs	
8	Réinitialisation du décodeur	8 (-)	Paramètre d'usine, la valeur n'est pas enregistrée
36	Lanterne d'aiguille allumée/éteinte	0-1 (1)	ne peut être défini que pendant la programmation

La procédure à suivre pour la programmation avec la Central Unit 6021 correspond à la programmation de la loco (www.maerklin.de -> Service -> Technische Informationen)

DCC

CV	Signification	Valeurs	
1	Adresse, octet de valeur basse	0-255 (1)	
7	Numéro de version fabricant (version logicielle)	(-)	Lire uniquement
8	Identifiant du fabricant Réinitialisation du décodeur	(131) 8 (-)	Lire uniquement, paramètre d'usine, la valeur n'est pas enregistrée
9	Adresse, octet de valeur supérieure	0-7 (0)	
29	Configuration	(192)	Lire uniquement
	Bits 0 à 4 non utilisés	0	
	Bit 5: Type de décodeur	0 / 32	Décodeur d'accessoires de base ou avancé
	Bit 6: Méthode d'adressage	0 / 64	Adresse du décodeur ou adresse de départ
	Bit 7: Type de décodeur	128	Décodeur d'accessoires
36	Lanterne d'aiguille allumée/éteinte	0-1 (1)	



Définition et calcul des adresses supérieures à 255 :

Par ex. Adresse 1044 -> 1044:256=4,078125 . La valeur avant la virgule (4) est à reporter dans la CV 9. La valeur située après la virgule (0,078125) est multipliée par 256 0,078125x256=20. La valeur calculée 20 est à reporter dans la CV 1.

Exploitation sous mfx

L'enregistrement mfx peut se faire sous MM ou DCC.

C'est le mode d'exploitation défini via le commutateur Dip 10 qui importe ici.

Avec la CS2 60213/60214/60215, l'enregistrement mfx est lancé dans la configuration des articles électromagnétiques via  >  et avec la CS3 60216/60226 dans la configuration des articles électromagnétiques via  > „Rechercher articles mfx“.

Remarque concernant la connexion mfx avec la CS2 :

Sélection possible „Affectation automatique d'un article électromagnétique“ sous „Configuration“ >  > „Voie“.

Si cette possibilité est cochée, l'enregistrement mfx se fait sur les premières adresses libres dans la CS2. Si cette possibilité n'est pas cochée, l'enregistrement mfx se fait sur les adresses réellement programmées sur le décodeur.

Beoogd gebruik

- Decoder voor de inbouw in de Märklin dubbele overwegwiel (DKW) 24720 of de Trix DKW 62720.
- De inbouw-digitaaldecoder mag bij het gebruik van een externe voeding alleen aan een Märklin of Trix netadapter aangesloten worden.
- Mag alleen in droge ruimtes gebruikt worden.
- De decoder mag niet worden gebruikt met analoge rijstroom.

Leveringsomvang

1 inbouw-digitaaldecoder

1 kabel geel, rood en bruin (C-rail Märklin)

1 kabel blauw, rood en wit (C-rail Trix)

Gebruiksaanwijzing

Garantiebewijs

Veiligheidsvoorschriften

- **Let op!** bevat vanwege zijn functie scherpe randen en punten.
- bedrading- en montage alleen in spanningloze toestand uitvoeren. Bij het niet naleven kunnen er gevaarlijke stromen door het lichaam vloeien en verwondingen ontstaan.
- **Decoder alleen met de toegelaten spanning** (zie technische gegevens) **gebruiken**.

Belangrijke aanwijzingen

- **Let op:** bij het inbouwen de delen op de bovenzijde van de inbouw-digitaaldecoder niet aanraken, statische ontlading kan de juiste werking beïnvloeden.
- De gebruiksaanwijzing is onderdeel van het product en moet derhalve bij de overdracht van het product meegegeven worden.
- Voor reparaties kunt u zich tot uw Märklin dealer wenden.
- <http://www.maerklin.com/en/imprint.html>

Technische gegevens

- | | |
|---------------------------------|----------------|
| • Belasting lantaarnuitgang | <100mA |
| • Belasting wisseluitgang | max. 2A |
| • Spanning digitale stroomkring | max. 20 V eff. |
| • Spanning extern | max. 20 V DC |
| • Diëlektrische sterkte | max. 40 V |

Werking

- Multiprotocol: fx (MM), mfx* en DCC
- Instellen van de bedrijfssoort met de dipschakelaars, zie pag. 34
- Instellen van het adres met DIP-schakelaar
1-256 fx (MM) (Control Unit 6021 / Central Station 1)
1-320 fx (MM) (Central Station 2/3 / Mobile Station 2)
1-511 (DCC)
- Programmeerbare adressen via CV
1-2044 DCC
- De **laatst ingestelde** adresinstelling is geldig, ongeacht of deze geprogrammeerd of met de dipschakelaars is ingesteld.
- Wijzigen van de eigenschappen via CV

* mfx pas vanaf CS 2 softwareversie 4.0

- Digitaal signaal: overdracht onafhankelijk van de stroomvoorziening.
- Stroomvoorziening via digitale stroomkring
- Alternatieve stroomvoorziening
- Soldeervelden voor het aansluiten van de wissellantaarn
- Wissellantaarn uit- en inschakelbaar

Decoder inbouwen

De volgende stappen mogen alleen in spanningloze toestand uitgevoerd worden:

- Steek de stekker van meegeleverde kabel in de daarvoor bestemde stekkerbus, zie pagina 28. Volg de afgebeelde aanwijzingen.

Veranderen van de te wijzigende eigenschappen in het fx (MM) protocol door CV programmering of het DCC CV programmering vindt u in het hoofdstuk "CV programmering".

Let op: instellingen van de DIP-schakelaars alleen in spanningloze toestand uitvoeren. De inbouw-digitaaldecoder herkent de actuele schakelaarstand pas na het inschakelen van de voedingsspanning.

CV Programmering

De CV programmering moet via het programmeerspoor gebeuren. Voor het programmeren is het aan te bevelen een fictive loc aan te maken. De waarden tussen haakjes zijn de af fabriek ingestelde waarden.

Tijdens de dataoverdracht knippert, ter controle, de aan de inbouw-digitaaldecoder aangesloten wisselantaarn.

De programmering kan naar wens via fx (MM) of DCC uitgevoerd worden. We adviseren de adresinstelling bij fx (MM) m.b.v. de dipschakelaars (zie pag. 34) uit te voeren.

fx (MM)

Voor het programmeren moet de te programmeren wissel met het keyboard geschakeld worden. Daarna onmiddellijk met de Control Unit resp. via CV configuratie met het Central Station de CV wijzigen. Direct daarna de opnieuw geprogrammeerde wissel weer met het keyboard schakelen. Pas dan is de programmering overgenomen en werkzaam.

CV	Omschrijving	Waarde	
8	Decoder reset	8 (-)	Fabrieksinstelling, waarde wordt niet geschreven
36	Wissellantaarn uit/aan	0-1 (1)	kan alleen worden ingesteld tijdens het programmeren

De werkwijze bij het programmeren met de Control Unit 6021 komt overeen met het programmeren van een locomotief-decoder (www.maerklin.de -> Service -> Technische Informatie(n)).

DCC

CV	Omschrijving	Waarde	
1	Adres, lage byte	0-255 (1)	
7	Fabrikant versienummer (softwareversie)	(-)	alleen lezen
8	Fabrikant kenmerk ID decoder reset	(131) 8 (-)	alleen lezen, fabrieksinstelling, waarde wordt niet geschreven
9	Adres, hoge byte	0-7 (0)	
29	Configuratie	(192)	alleen lezen
	Bit 0-4 worden niet gebruikt	0	
	Bit 5: decodertype	0 / 32	Basis- of uitgebreide toebehoren decoder
	Bit 6: adresseringsmethode	0 / 64	Decoder of uitgangsadres
	Bit 7: decodertype	128	Toebehoren decoder
36	Wissellantaarn uit/aan	0-1 (1)	

Instellen en berekenen van de adressen groter dan 255:

Bijv. adres 1044 -> $1044:256=4,078125$. De waarde voor de komma (4) moet in CV 9 ingevoerd worden. De waarde achter de komma (0,078125) wordt nu met 256 vermenigvuldigd $0,078125 \times 256=20$. De berekende waarde 20 moet in CV 1 ingevoerd worden.

Bedrijf met mfx

De mfx aanmelding kan zowel onder MM als onder DCC gebeuren.

Bepalend daarvoor is het ingestelde bedrijfstype met dip-schakelaar 10.

De mfx aanmelding wordt met het CS2 60213/60214/60215 in de magneetartikel configuratie via  >  en met het CS3 60216/60226 in de magneetartikelen configuratie via  > "mfx-artikel zoeken" gestart.

Opmerking t.a.v. mfx aanmelding met het CS2

Keuzemogelijkheid "Magneetartikelen automatisch toewijzen" onder "Setup" >  "Rail".

Als daar het vinkje gezet is, vindt de mfx-aanmelding plaats op de eerste vrije adressen in het CS2. Is het vinkje niet gezet, dan vindt de mfx-aanmelding op het werkelijke, op de decoder geprogrammeerde adres plaats.

Uso previsto

- Decoder para la instalación en la travesía de unión doble de Märklin 24720 o en la travesía de unión doble de Trix 62720.
- Está permitido conectar el decoder digital integrable, en el caso de alimentación externa, únicamente a fuentes de alimentación conmutadas de Märklin o de Trix.
- Su uso está permitido únicamente en recintos secos.
- No está permitido utilizar el decoder con corriente de tracción analógica.

Alcance de suministro

1 decoder digital integrable

1 cable amarillo, rojo y marrón (vía C de Märklin)

1 cable azul, rojo y blanco (vía C de Trix)

Instrucciones de montaje

Documento de garantía

Instrucciones de seguridad

- **¡ATENCIÓN!** El diseño presenta aristas y puntas cortantes impuestas por las características funcionales.
- Ejecutar los trabajos de cableado y montaje únicamente sin tensión. En el caso de inobservancia pueden producirse corrientes peligrosas a través del cuerpo y, por tanto, lesiones.
- **Utilizar el decoder únicamente con la tensión admisible** (véase Datos técnicos).

Notas importantes

- **Atención:** En el montaje, a ser posible, no tocar componentes situados en el lado superior del decoder digital integrable ya que las cargas estáticas pueden perjudicar a su funcionamiento.
- Las instrucciones de empleo forman parte integrante del producto y, por este motivo, deben conservarse y entregarse al nuevo comprador en el caso de venta del mismo.
- Para reparaciones, por favor diríjase a su distribuidor especializado de Märklin.
- <http://www.maerklin.com/en/imprint.html>

Datos técnicos

- | | |
|-------------------------------|----------------|
| • Carga por salida de farol | ≤ 100 mA |
| • Carga por salida de desvío | max. 2 A |
| • Tensión de circuito digital | máx. 20 V efi. |
| • Tensión externa | máx. 20 V DC |
| • Rigidez dieléctrica | máx. 40 V |

Funciones

- Apto para múltiples protocolos: fx (MM), mfx* y DCC
- Configuración del modo de funcionamiento mediante microinterruptores DIP, véase página 34
- Direcciones configurables mediante interruptor DIP:
1-256 fx (MM) (Control Unit 6021 / Central Station 1)
1-320 fx (MM) (Central Station 2/3 / Mobile Station 2)
1-511 (DCC)

- Direcciones programables mediante variables CV
1-2.044 DCC
- la dirección válida es la **última** dirección configurada, ya sea mediante programación o mediante microinterruptores DIP
- Modificación de las características mediante variables CV
- Señal digital: Transmisión independiente de la alimentación eléctrica
- Alimentación eléctrica mediante circuito digital.
- Alimentación eléctrica alternativa
- Terminales de soldadura para conexión de farol de aguja
- Farol de aguja activable o desactivable

Montaje del decoder

Está permitido ejecutar las siguientes operaciones únicamente sin tensión.

- Enchufe el cable incluido en el conector hembra para ello previsto, véase página 28. Siga ahora las instrucciones ilustradas.

En el capítulo "Programación de las CVs" se explican las modificaciones de las demás características en el protocolo fx (MM) mediante programaciones de variables CV o para la programación de variables CV en el protocolo DCC.

Nota importante: Realizar los ajustes con el microinterruptor DIP siempre sin tensión. El decoder digital integrable no reconoce las posiciones actuales de los microinterruptores hasta que no se enciende la alimentación eléctrica.

Programación de variables CV

La programación de variables CV debe realizarse en la vía de programación. Para la programación recomendamos crear una locomotora ficticia. Los valores entre paréntesis representan la configuración de fábrica.

Durante la transmisión de datos, para comprobación, destella el farol de aguja conectado al decoder digital integrable.

La programación se puede realizar opcionalmente vía fx (MM) o DCC. Recomendamos configurar la dirección en el caso de fx (MM) mediante microinterruptores DIP (véase página 34 y siguientes).

fx (MM)

Antes de la programación, debe conmutarse con el Keyboard el desvío que se desee programar. Inmediatamente después debe modificarse la CV con la Control Unit o bien con la función Configuración de CV de la Central Station. Acto seguido, maniobrar de nuevo con el keyboard el desvío recién programado. Hasta que esto no se haya hecho no se aplicará ni tendrá efecto la programación.

CV	Significado	Valores	
8	Reset de decoder	8 (-)	Configuración de fábrica, no se escribe el valor
36	Apagar/encender farol de aguja	0-1 (1)	sólo puede ajustarse durante la programación

El procedimiento en la programación con la Central Unit equivale a la programación de locomotora (www.maerklin.de -> Service -> Technische Informationen).

DCC



CV	Significado	Valores	
1	Dirección, byte de menor peso	0-255 (1)	
7	Número de versión de fabricante (versión de software)	(-)	Sólo lectura
8	ID ident. de fabricante Reset de decoder	(131) 8 (-)	Sólo lectura, configuración de fábrica, no se escribe el valor
9	Dirección, byte de mayor peso	0-7 (0)	
29	Configuración	(192)	Sólo lectura
	Bit 0-4 No se utilizan los bits	0	
	Bit 5: Modelo de decoder	0 / 32	Decoder accesorio básico o ampliado
	Bit 6: Método de direccionamiento	0 / 64	Dirección de decoder o inicial
	Bit 7: Tipo de decoder	128	Decoder accesorio
36	Desactivar/activar farol de desvío	0-1 (1)	

Configuración y cálculo de las direcciones mayores que 255:

P. ej., dirección 1044 -> $1044:256=4,078125$. El valor antes de la coma (4) debe registrarse en la CV 9. El valor después de la coma (0,078125) se multiplica por 256 $0,078125 \times 256=20$. El valor calculado 20 debe registrarse en CV 1.

Funcionamiento en modo mfx

El inicio de sesión en mfx se puede realizar en modo MM o DCC. El modo de funcionamiento se selecciona con el microinterruptor DIP 10.

El inicio de sesión en modo mfx se inicia con la CS2 60213/60214/60215 en la configuración de artículos magnéticos a través de  >  y con la CS3 60216/60226 en la configuración de artículos magnéticos a través de  > "Buscar artículos mfx".

Nota sobre el inicio de sesión en mfx con la CS2:

Posibilidad de selección de „Asignar automáticamente artículos magnéticos” en „Setup (configuración)” >  > „Vía”.

Si en estas funciones se ha activado la marca de verificación, el inicio de sesión en modo mfx se realiza en las primeras direcciones libres de la CS2. Si no está activada la marca de verificación, el inicio de sesión en mfx se realiza en las direcciones realmente programadas en el decoder.

Impiego commisurato alla destinazione

- Decoder per il montaggio nel deviatore inglese doppio Märklin (DKW) 24720 oppure nel DKW 62720 Trix.
- Tale Decoder Digital installabile in caso di un'alimentazione di corrente esterna deve venire collegato solamente ad alimentatori «switching» da rete Märklin o rispettivamente Trix.
- Deve essere impiegato solamente in luoghi asciutti.
- Tale Decoder non deve venire messo in funzione con corrente di trazione analogica.

Corredo di fornitura

1 Decoder Digital installabile

1 cavetto giallo, rosso e marrone (binario Märklin C)

1 cavetto blu, rosso e bianco (binario Trix C)

Istruzioni di montaggio

Certificato di garanzia

Avvertenze di sicurezza

- **ATTENZIONE!** Spigoli e punte affilati per necessità funzionale.
- Si eseguano i lavori di cablaggio e di montaggio solo in condizioni esenti da tensione. In caso di mancato rispetto questo può condurre a pericolose correnti nel corpo e di conseguenza a ferimenti.
- **Si faccia funzionare il Decoder solamente con la tensione ammissibile** (si vedano i dati tecnici).

Avvertenze importanti

- **Attenzione:** durante il montaggio si tocchino il meno possibile i componenti sul lato superiore del Decoder Digital installabile, le cariche statiche possono compromettere la funzionalità.
- Le istruzioni di impiego costituiscono parte integrante del prodotto e devono pertanto venire conservate con cura nonché consegnate insieme in caso di cessione a terzi del prodotto.
- Per riparazioni Vi preghiamo di rivolgerVi al Vostro rivenditore specialista Märklin.
- <http://www.maerklin.com/en/imprint.html>

Dati tecnici

- Carico dell'uscita per lanterne ≤ 100 mA
- Carico dell'uscita per deviatori max. 2 A
- Tensione nel circuito di corrente Digital max. 20 V eff.
- Tensione esterna max. 20 V DC
- Rigidità dielettrica max. 40 V

Funzioni

- Capacità multi-protocollo: fx (MM), mfx* und DCC
- Impostazione del tipo di funzionamento per mezzo dei commutatori DIP, si veda pagina 34
- Indirizzi impostabili con commutatori DIP:
1-256 fx (MM) (Control Unit 6021 / Central Station 1)
1-320 fx (MM) (Central Station 2/3 / Mobile Station 2)
1-511 (DCC)
- Indirizzi programmabili tramite CV: **1-2.044** DCC
- Valevole è **rispettivamente l'ultima** impostazione di indirizzo, ugualmente se tramite programmazione oppure tramite commutatori DIP.

* mfx solo a partire da CS 2 con Software versione 4.0

- Modificazione delle caratteristiche tramite CV
- Segnale Digital: trasmissione indipendente dall'alimentazione di corrente
- Alimentazione di corrente tramite circuito di corrente Digital
- Alimentazione di corrente alternativa
- Piazzole da saldare per collegamento della lanterna da deviatoi
- Lanterna da deviatoi disattivabile o attivabile

Montaggio del Decoder

I seguenti passaggi del lavoro devono essere eseguiti solamente in condizioni esenti da tensione.

- Innestate il cavetto fornito in dotazione nella presa predisposta a tale scopo, si veda a pagina 28. Seguite adesso le istruzioni illustrate.

Per modificazioni delle altre caratteristiche nel protocollo fx (MM) mediante programmazione delle CV oppure per programmazione delle CV in DCC seguite il capitolo «Programmazione delle CV.»

Prestate attenzione: si intraprendano le impostazioni con il commutatore DIP sempre senza tensione. Il Decoder Digital installabile riconosce le attuali disposizioni del commutatore solo con l'attivazione della tensione.

Programmazione delle CV

La programmazione delle CV deve avvenire sul binario di programmazione. Per tale programmazione noi consigliamo di inserire una locomotiva immaginaria. I valori tra parentesi sono le impostazioni di fabbrica.

Durante la trasmissione dei dati lampeggia per controllo la lanterna da deviatoi collegata al Decoder Digital installabile.

La programmazione può avvenire a scelta mediante fx (MM) oppure DCC. In caso di fx (MM) noi consigliamo di eseguire l'impostazione dell'indirizzo per mezzo dei commutatori DIP (si veda 34 e seg.).

fx (MM)

Prima della programmazione il deviatoio da programmare deve venire commutato con la Keyboard. Dopo di ciò le CV vengono immediatamente modificate con la Control Unit o rispettivamente la configurazione CV della Central Station. Direttamente dopo, commutare nuovamente con la Keyboard i deviatoi appena programmati. Soltanto ora la programmazione è acquisita ed operativa.

CV	Significato	Valori	
8	Ripristino Decoder	8 (-)	Impostazioni di fabbrica, il valore non viene scritto
36	Lanterna da deviatoi spenta/accesa	0-1 (1)	può essere impostato solo durante la programmazione

Il modo operativo nella programmazione con la Central Unit 6021 corrisponde alla programmazione della locomotive (www.maerklin.de -> Service -> Technische Informationen).

DCC



CV	Significato	Valori	
1	Indirizzo, byte di valore più basso	0-255 (1)	
7	Numero di versione del fabbricante (Versione Software)	(-)	sola lettura
8	ID identificativo del fabbricante Ripristino Decoder	(131) 8 (-)	sola lettura, Impostazioni di fabbrica, il valore non viene scritto
9	Indirizzo, byte di valore più alto	0-7 (0)	
29	Configurazione	(192)	sola lettura
	I bit 0-4 non vengono usati	0	
	Bit 5: tipo di Decoder	0 / 32	Decoder per accessori di base o esteso
	Bit 6: metodo di indirizzamento	0 / 64	Indirizzo Decoder o di uscita
	Bit 7: tipo di Decoder	128	Decoder per accessori
36	Lanterna da deviatore spenta/accesa	0-1 (1)	

Impostazione e calcolo degli indirizzi maggiori di 255:

Ad es. indirizzo 1044 -> $1044:256=4,078125$. Il valore prima della virgola (4) si deve inserire in CV 9. Il valore dopo la virgola (0,078125) viene moltiplicato per 256: $0,078125 \times 256=20$. Il valore calcolato 20 deve venire inserito in CV 1.

Esercizio sotto mfx

La registrazione mfx può avvenire sotto MM oppure DCC. È discriminante il tipo di funzionamento impostato tramite il commutatore Dip 10.

La registrazione mfx viene avviata con la CS2 60213/60214/60215 nella configurazione degli apparati elettromagnetici tramite  >  e con la CS3 60216/60226 nella configurazione degli apparati elettromagnetici tramite  > „ricerca apparati mfx“.

Avvertenza sull'iscrizione mfx con la CS2:

Possibilità di selezione „Assegnare automaticamente apparati elettromagnetici“ sotto „Setup“ >  > „Binario“.

Se colà è posto il segno di spunta la registrazione mfx avviene sul primo indirizzo libero nella CS2. Se il segno di spunta non è collocato, la registrazione mfx avviene sull'indirizzo effettivamente programmato sul Decoder.

Användningsområde

- Dekoder för inbyggnad i Märklins dubbelkorsväxlar (DKV) 24720 eller Trix DKV 62720.
- Inbyggnadsdekodern får vid extern strömförsörjning endast anslutas till Märklins eller Trix nätenhet.
- Den får endast användas i torra rum och utrymmen.
- Dekodern får inte/aldrig matas med analog körström.

Ingående material vid leverans

- 1 inbyggnadsdekode
- 1 gul, röd och brun kabel (Märklin C-räls)
- 1 blå, röd och vit kabel (Trix-C-räls)
- Inbyggnadsanvisningar
- Garantisedel

Säkerhetsanvisningar

- **WARNING!** Funktionsbetingade skarpa kanter och spetsiga delar.
- Anslutning av kablar och montagearbeten får endast göras i spänningslöst tillstånd. Om dessa anvisningar ej följs kan det leda till farliga strömmar och strömstyrkor som kan åsamka kroppsskada.
- **Dekodern får endast drivas med angiven spänning** (se tekniska data).

Viktig information

- **Varning:** Vid montage, undvik att beröra inbyggnadsdekoderns ovansida, statisk elektricitet kan skada dekoderns funktioner.
- Bruksanvisningen tillhör produkten och måste därför sparas och medfölja produkten om den överläts till annan ägare.

- För eventuella reparationer vänder man sig till sin Märklin-fackhandel.
- <http://www.maerklin.com/en/imprint.html>

Tekniska data

- Belastning lyktutgång ≤ 100 mA
- Belastning växeltutgång max. 2 A
- Spänning digitalströmkrets max. 20 V eff.
- Spänning externt max. 20 V DC
- Spänningsstyrka max. 40 V

Funktioner

- För multiprotokoll: fx (MM), mfx* och DCC
- Inställning av driftstyp med dip-switchar, se sidan 34
- Inställbara adresser med DIP-switchar
1-256 fx (MM) (Control Unit 6021 / Central Station 1)
1-320 fx (MM) (Central Station 2/3 / Mobile Station 2)
1-511 (DCC)
- Programmerbara adresser via CV
1-2.044 DCC
- Det är alltid den **senast inställda** adressen som gäller, oavsett om inställningen gjorts med körkontrollen eller med dip-switcharna.
- Ändringar av egenskaper via CV
- Digitalsignal: Överföring oberoende av strömförsörjningen.
- Strömförsörjning via digitalströmkrets
- Alternativ strömförsörjning
- Lödöar för anslutning av växellyktan
- Växellyktan kan kopplas till och från

* mfx först fr.o.m. CS 2 softwareversion 4.0

Inbyggnad av dekodern

Följande åtgärder får endast utföras i spänningslöst tillstånd.

- Stick in de medföljande kablarna i de därför avsedda anslutningspunkterna, se sidan 28. Följ anvisningarna på bilderna.

Ändringar av andra egenskaper i fx (MM) protokoll via CV programmering eller via DCC CV-programmering görs enligt anvisningarna i kapitlet "CV programmering".

Observera: Inställningar av DIP-switcharna får endast göras i spänningslöst tillstånd. Inbyggnadsdekodern godkänner inte de aktuella inställningarna förrän spänningen kopplas på.

CV programmering

CV programmering måste göras på programmeringsspåret. För programmeringen rekommenderar vi att man lägger till ett fiktivt lok. Värden angivna inom klammer är fabriksinställningarna.

För kontroll: Under dataöverföringen blinkar den till inbyggnadsdekodern anslutna växellyktan.

Programmering/inställning kan enligt önskemål göras med fx (MM) eller med DCC. Används fx (MM) rekommenderar vi att göra inställningarna med DIP-switcharna (se 34 ff).

fx (MM)

Innan programmeringen måste den aktuella växeln som ska programmeras kopplas och styras via Keyboard. Därefter måste CV ändras omedelbart via Control Units eller t.ex. Central Stations CV konfiguration. Därefter kan de nyprogrammerade växlarna åter manövreras med Keyboard. Först då är programmeringen slutförd och fungerar.

CV	Betydelse	Värden	
8	Dekoder-reset	8 (-)	Fabriksinställningar, värden sparas ej
36	Växellykta till/från	0-1 (1)	kan endast ställas in under programmeringen

Tillvägagångssättet vid programmering med Central Unit 6021 motsvarar lokprogrammeringen (www.maerklin.de -> Service -> Technische Informationen).

DCC

CV	Betydelse	Värden	
1	Adresser, lågvärdiga Byte	0-255 (1)	
7	Tillverkarens versionsnummer (Mjukvaruversion)	(-) 8	endast läsning
8	Tillverkarens ID Dekoder reset	(131) 8 (-)	endast läsning, fabriksinställning, värden sparas ej
9	Adresser, högvärdiga Byte	0-7 (0)	
29	Konfiguration	(192)	endast läsning
	Bit 0-4 används ej	0	
	Bit 5: Dekodertyp	0 / 32	Standarddekoder eller tillagd tillbehörsdekoder
	Bit 6: Adresseringsmetod	0 / 64	Dekoder- eller utgångsadress
	Bit 7: Dekodersort	128	Tillbehörsdekoder
36	Växellykta, från/till	0-1 (1)	

Inställning och åtkomst av adresser högre än 255:

T.ex. adress 1044 -> $1044:256=4,078125$. För in detta värde före kommatecknet (4) i CV 9. Värdet efter kommatecknet (0,078125) multipliceras med 256, $0,078125 \times 256=20$. Det erhållna värdet måste införas i CV 1.

Körning med mfx

Mfx-inställning kan göras med både MM och DCC.

Drifttyp ställs in med hjälp av dip-switch nr 10.

Mfx-inställningen görs med CS2 60213/60214/60215 i magnetartikelkonfigurationen via  > 
och med CS3 60216/60226 i magnetartikelkonfigurationen via  > "sökning av mfx-artiklar".

Information om mfx-inställning med CS2:

Valmöjlighet: "Automatisk tilldelning av magnetartikel" under "Setup" >  > "spår".

Om man markerar detta val så genomförs mfx-inställningen på den första lediga adressen i CS2. Om man inte markerar detta så genomförs mfx-inställningen på den adress som dekodern redan är inställd på.

Hensigtsmæssig anvendelse

- Dekoder til installation i Märklins dobbelte krydsningsspor-skifte (DKS) 24720 eller Trix DKS 62720.
- Den digitale indbygningsdekoder må ved ekstern strømforsyning kun tilsluttes Märklin hhv. Trix strømforsyninger.
- Må kun anvendes i tørre rum.
- Dekoderen må ikke bruges med analog kørestrøm.

Leveringsomfang

- 1 digital indbygningsdekoder
- 1 kabel gult, rødt og brunt (C-spor Märklin)
- 1 kabel blå, rødt og hvidt (C-spor Trix)
- Montagevejledning
- Garantibevis

Sikkerhedsbemærkninger

- **BEMÆRK!** Funktionsbetingede skarpe kanter og spidser.
- Udfør kun kabel- og montagearbejde uden spænding. Hvis man ikke iagttager dette, kan der forekomme farlige strømme gennem kroppen, som kan medføre kvæstelser.
- **Anvend kun dekoderen med den tilladte spænding** (se tekniske data).

Vigtige bemærkninger

- **Bemærk:** Undgå ved montagen om muligt at berøre komponenter på den digitale indbygningsdekoders overside, statisk opladning kan skade funktionen.
- Betjeningsvejledningen er en bestanddel af produktet og skal derfor gemmes samt gives med, hvis produktet gives videre.
- For reparation bedes du henvende dig til din Märklin

forhandler.

- <http://www.maerklin.com/en/imprint.html>

Tekniske data

- Belastning laterneudgang ≤ 100 mA
- Belastning sporskifteudgang max. 2 A
- Spænding digitalkredsløb max. 20 V eff.
- Spænding ekstern max. 20 V DC
- Spændingssikring max. 40 V

Funktioner

- Multiprotokoldygtig: fx (MM), mfx* og DCC
- Indstilling af driftsmodus ved hjælp af DIP-kontakt, se side 34
- Indstillelige adresser med DIP-kontakt:
1-256 fx (MM) (Control Unit 6021 / Central Station 1)
1-320 fx (MM) (Central Station 2/3 / Mobile Station 2)
1-511 (DCC)
- Programmerbare adresser via CV
1-2.044 DCC
- Den **sidste** adresseindstilling er gyldig, uanset om den er indstillet via programmering eller DIP-kontakt.
- Ændringer af egenskaberne via CV
- Digitalsignal: Overførsel uafhængig af strømforsyningen
- Strømforsyning via digitalkredsløb
- Alternativ strømforsyning
- Loddepads til tilslutning af sporskiftelaterne
- Sporskiftelaterne kan tændes og slukkes

* mfx først fra CS 2 Softwareversion 4.0

Indbygning af dekoder

De følgende arbejds-kridt må kun foretages uden elektrisk spænding.

- Stik det medleverede kabel i det forberedte stik, se side 28. Følg nu den illustrerede vejledning.

Til ændring af de andre egenskaber i fx (MM) protokollen via CV programmering eller til DCC CV-programmering følg kapitlet "CV programmering."

Bemærk venligst: Foretag altid indstillinger med DIP-kontakten uden elektrisk spænding. Den digitale indbygningsdekoder genkender først de gældende indstillinger, når der tændes for spændingen.

CV programmering

CV programmeringen skal foregå på programmeringsspoet. Til programmeringen anbefaler vi at oprette et fiktivt lokomotiv. Værdier i parentes er fabriksindstillingerne.

Programmeringen kan valgfrit foretages via fx (MM) eller DCC. Indstilling af adresse anbefales foretaget via DIP-kontakt til fx (MM) (se 34 og frem).

fx (MM)

Før programmeringen skal det sporskifte, der skal programmeres, omskiftes fra keyboardet. Derefter skal CV omgående ændres med Control Unit hhv. Central Stations CV konfiguration. Derefter skal det nyprogrammerede sporskifte omgående aktiveres ved hjælp af tastaturet. Først nu er programmeringen overtaget og i effekt.

CV	Betydning	Værdier	
8	Dekoder-reset	8 (-)	Fabriksindstilling, værdi skrives ikke
36	Sporskiftelaterne sluk/tænd	0 – 1 (1)	kan kun indstilles under programmering

Fremgangsmåden ved programmering med Central Unit 6021 svarer til lokomotivprogrammeringen (www.maerklin.de -> Service -> Technische Informationen).

DCC

CV	Betydning	Værdier	
1	Adresse, lavværdi byte	0-255 (1)	
7	Producent versionsnummer (softwareversion)	(-)	kun læse
8	Producent mærkning ID dekoder reset	(131) 8 (-)	kun læse, fabriksindstilling, værdi skrives ikke
9	Adresse, højeværdi byte	0-7 (0)	
29	Konfiguration	(192)	kun læse
	Bit 0-4 anvendes ikke	0	
	Bit 5: dekodertype	0 / 32	basis- el. udvidet tilbehørsdekoder
	Bit 6: adresseringsmetode	0 / 64	dekoder- el. udgangsadresse
	Bit 7: dekoderart	128	tilbehørsdekoder
36	Sporskiftelaterne, sluk/tænd	0-1 (1)	

Indstilling og udregning af adresser højere end 255:

F.eks. adresse 1044 -> 1044:256=4,078125 . Værdien foran kommaet (4) skal indgives i CV 9. Værdien efter kommaet (0,078125) multipliceres med 256, 0,078125x256=20. Den udregnede værdi 20 skal indgives i CV 1.

Drift med mfx

mfx-registreringen kan ske med MM eller DCC.

Den ved hjælp af dip-omskifter indstillede driftsmodus er afgørende.

mfx-registreringen indledes med CS2 60213/60214/60215 i magnetartikelkonfigurationen via  >  og med CS3 60216/60226 i magnetartikelkonfigurationen via  > „søg mfx-artikel“.

Vigtigt vedrørende mfx-registreringen med CS2:

Valgmulighed „tildel magnetartikel automatisk“ under „Setup“ >  > „Spor“.

Er fluebenet sat ved dette punkt, sker mfx-registreringen på de første frie adresser i CS2. Er fluebenet ikke sat ved dette punkt, sker mfx-registreringen på de effektivt ved dekoderen programmerede adresser.

**Märklin C-Gleis / Märklin C Track / Voie C Märklin / Märklin C-rail /
Via C de Märklin / Binario Märklin C / Märklin C-skenor / Märklin C-spor**

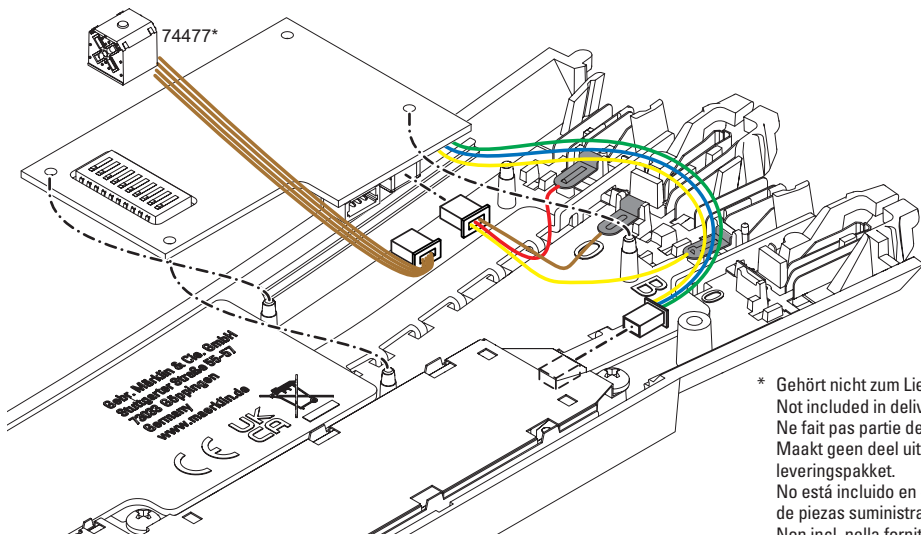

* Gehört nicht zum Lieferumfang.
Not included in delivery scope.
Ne fait pas partie de la fourniture.
Maakt geen deel uit van het
leveringspakket.
No está incluido en el conjunto
de piezas suministradas.
Non incl. nella forniture.
Ingår inte i leveransen.
Medleveres ikke.

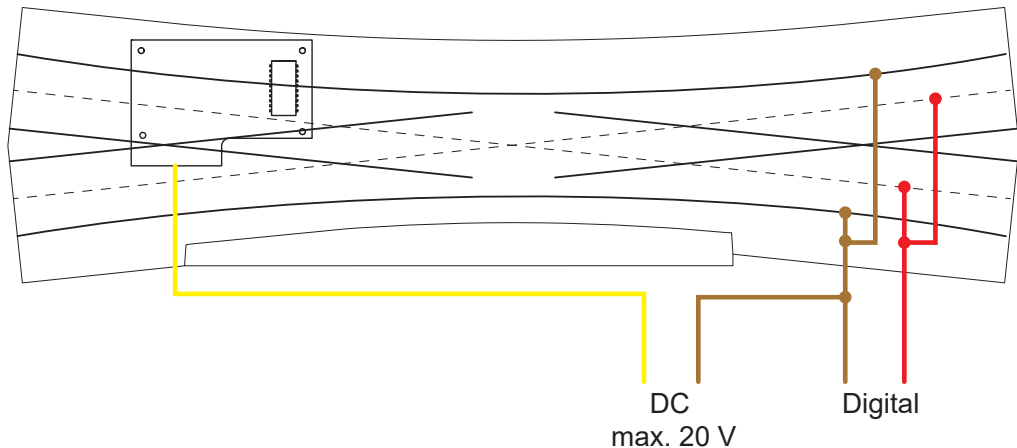

Alternative Stromversorgung Märklin:

Verbinden Sie das gelbe Kabel mit einer externen Stromquelle. Den anderen freien Pol der externen Stromversorgung verbinden Sie mit dem braunen Kabel des Digital-Stromkreises.

Das gelbe Kabel des Einbau-Digital-Decoders darf nicht zusätzlich mit dem Digital-Stromkreis verbunden werden.

Alternative Power Supply for Märklin:

Connect the yellow wire to an external power source. The other available terminal on the external power supply can be connected to the brown wire for the digital power circuit.

The yellow wire from the digital installation decoder may not be connected with the digital power circuit.

Alternatieve stroomvoorziening **Märklin:**

Verbind de gele draad met een externe stroombron. De andere vrije aansluiting van de externe stroombron moet worden verbonden met de bruine draad van de digitale stroomkring.

De gele draad van de inbouw-digitaaldecoder mag niet met de digitale stroomkring verbonden worden.

Alimentation en courant alternative **Märklin :**

Reliez le câble jaune à une source d'alimentation extérieure. Reliez le second pôle libre de l'alimentation en courant extérieure avec le câble marron du circuit électrique numérique.

Le câble jaune du décodeur numérique ne doit en aucun cas être raccordé au circuit électrique numérique.

Alimentazione di corrente alternativa **Märklin:**

Vogliate collegare il cavetto giallo con una sorgente di corrente esterna. L'altro polo libero dell'alimentazione di corrente esterna collegatelo con il cavetto marrone del circuito di corrente Digital.

Il cavetto giallo del Decoder Digital installabile non deve venire collegato con il circuito di corrente Digital.

Alimentación eléctrica de **Märklin:**

Conecte el cable amarillo a una fuente de corriente externa.

Conecte el otro polo libre de la alimentación eléctrica externa al cable marrón del circuito digital.

El cable amarillo del decoder digital integrable no debe conectarse con el circuito digital.

Alternativ strömförsörjning **Märklin:**

Den gula kabeln skall anslutas till en extern strömkälla. Den andra polen på den externa strömkällan ansluts till den digitala strömkretsens bruna kabel.

Inbyggnadsdekoderns gula kabel får absolut INTE komma i kontakt med den digitala strömkretsen.

Alternativ strømforsyning **Märklin:**

Forbind det gule kabel med en ekstern strømkilde. Den eksterne strømforsynings anden fri pol forbindes med det digitale strømkredsløbs brune kabel.

Den digitale indbygningsdekoders gule kabel må ikke forbindes med det digitale strømkredsløb.

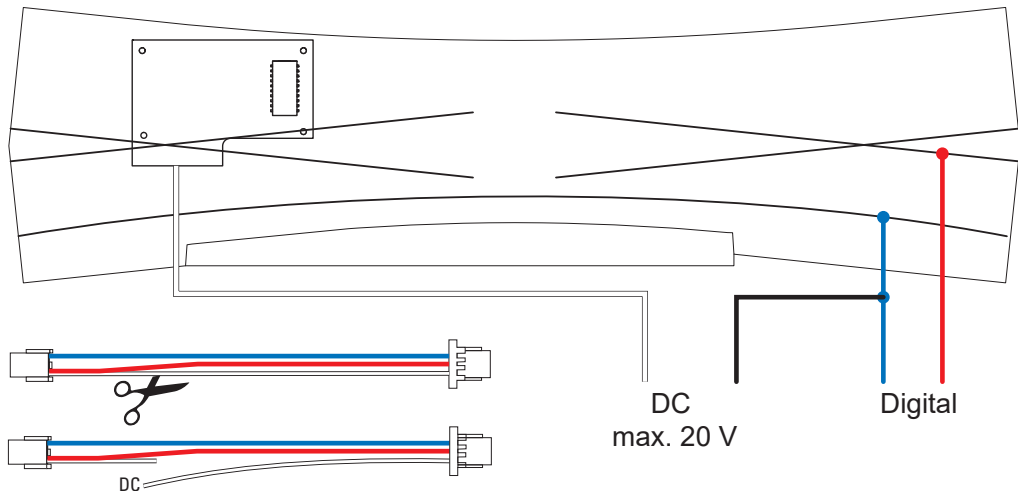

Alternative Stromversorgung **Trix**:

Durchtrennen Sie das weiße Kabel und verbinden Sie es mit einer externen Stromquelle. Den anderen freien Pol der externen Stromversorgung verbinden Sie mit dem Massekabel (braun/blau) des Digital-Stromkreises.

Das weiße Kabel des Einbau-Digital-Decoders darf nicht mit dem Digital-Stromkreis verbunden werden.

Alternative Power Supply for **Trix**:

Cut the white wire as shown and connect it to an external power source. The other available terminal on the external power supply can be connected to the ground wire (brown/blue) for the digital power circuit.

The white wire from the digital installation decoder may not be connected with the digital power circuit.

Alimentation en courant alternative **Trix** :

Sectionnez le câble blanc et reliez-le à une source d'alimentation en courant extérieure. Reliez le second pôle libre de l'alimentation en courant extérieure avec le câble de masse (marron/bleu) du circuit électrique numérique.

Le câble blanc du décodeur numérique ne doit en aucun cas être raccordé au circuit électrique numérique.

Alternatieve stroomvoorziening **Trix**:

Knip de witte draad door en verbind deze draad met een externe stroombron. De andere vrije aansluiting van de externe stroombron moet worden verbonden met de massadraad (bruine/blauwe) draad van de digitale stroomkring.

De witte draad van de inbouw-digitaaldecoder mag niet met de digitale stroomkring verbonden worden.

Alimentazione di corrente alternativa **Trix**:

Vogliate sezionare il cavetto bianco e collegatelo con una sorgente di corrente esterna. L'altro polo libero dell'alimentazione di corrente esterna collegatelo con il cavetto di massa (marrone/blu) del circuito di corrente Digital.

Il cavetto bianco del Decoder Digital installabile non deve venire collegato con il circuito di corrente Digital.

Alimentación eléctrica alternativa **Trix**:

Seccione el cable blanco y conéctelo a una fuente de corriente externa. Conecte el otro polo libre de la fuente de alimentación externa al cable de masa (marrón/azul) de circuito digital.

El cable blanco del decoder digital integrable no debe conectarse al circuito digital.

Alternativ strömförsörjning **Trix**:

Separera den vita kabeln och koppla den till en extern strömkälla. Den andra polen på den externa strömkällan ansluts till den digitala strömkretsens jordkabel (brun/blå).

Den vita kabeln får absolut INTE komma i kontakt med den digitala strömkretsen.

Alternativ strømforsyning **Trix**:

Klip det hvide kabel over og forbind det med en ekstern strømkilde. Den eksterne strømforsynings anden fri pol forbindes med det digitale strømkredsløbs jordkabel (brun/blå).

Den digitale indbygningsdekoders hvide kabel må ikke forbindes med det digitale strømkredsløb.

Betriebsart und Adressen einstellen

Pos 10: on = DCC, off = fx (MM)

Setting the mode of operation and addresses

Pos 10: on = DCC, off = fx (MM)

Définir le mode d'exploitation et les adresses

Pos 10: on = DCC, off = fx (MM)

Bedrijfsmodus en adres instellen

Pos 10: on = DCC, off = fx (MM)

Configuración de modo de funcionamiento y direcciones

Pos 10: on = DCC, off = fx (MM)

Impostate tipo di funzionamento e indirizzi

Pos 10: on = DCC, off = fx (MM)

Ställ in driftstyp och adress



Pos 10: on = DCC, off = fx (MM)



Indstil driftsart og adresser

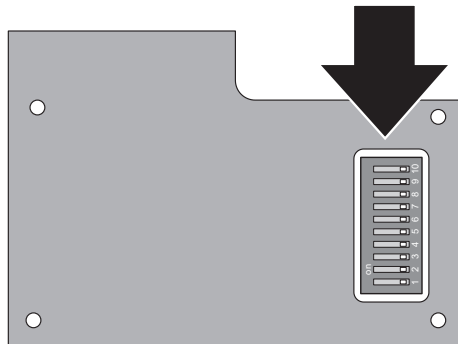
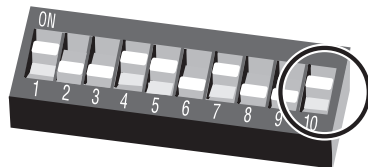

Pos 10: on = DCC, off = fx (MM)



on = DCC
off = fx (MM)









			10 (0/1)	
1	1 1	1		fx (MM)/DCC
2	1 2	2		fx (MM)/DCC
3	1 3	1 2		fx (MM)/DCC
4	1 4	3		fx (MM)/DCC
5	1 5	1 3		fx (MM)/DCC
6	1 6	2 3		fx (MM)/DCC
7	1 7	1 2 3		fx (MM)/DCC
8	1 8	4		fx (MM)/DCC
9	1 9	1 4		fx (MM)/DCC
10	1 10	2 4		fx (MM)/DCC
11	1 11	1 2 4		fx (MM)/DCC
12	1 12	3 4		fx (MM)/DCC
13	1 13	1 3 4		fx (MM)/DCC
14	1 14	2 3 4		fx (MM)/DCC
15	1 15	1 2 3 4		fx (MM)/DCC
16	1 16	5		fx (MM)/DCC
17	2 1	1 5		fx (MM)/DCC
18	2 2	2 5		fx (MM)/DCC
19	2 3	1 2 5		fx (MM)/DCC
20	2 4	3 5		fx (MM)/DCC
21	2 5	1 3 5		fx (MM)/DCC
22	2 6	2 3 5		fx (MM)/DCC
23	2 7	1 2 3 5		fx (MM)/DCC
24	2 8	4 5		fx (MM)/DCC
25	2 9	1 4 5		fx (MM)/DCC



			10 (0/1)	
26	2 10	2 4 5		fx (MM)/DCC
27	2 11	1 2 4 5		fx (MM)/DCC
28	2 12	3 4 5		fx (MM)/DCC
29	2 13	1 3 4 5		fx (MM)/DCC
30	2 14	2 3 4 5		fx (MM)/DCC
31	2 15	1 2 3 4 5		fx (MM)/DCC
32	2 16	6		fx (MM)/DCC
33	3 1	1 6		fx (MM)/DCC
34	3 2	2 6		fx (MM)/DCC
35	3 3	1 2 6		fx (MM)/DCC
36	3 4	3 6		fx (MM)/DCC
37	3 5	1 3 6		fx (MM)/DCC
38	3 6	2 3 6		fx (MM)/DCC
39	3 7	1 2 3 6		fx (MM)/DCC
40	3 8	4 6		fx (MM)/DCC
41	3 9	1 4 6		fx (MM)/DCC
42	3 10	2 4 6		fx (MM)/DCC
43	3 11	1 2 4 6		fx (MM)/DCC
44	3 12	3 4 6		fx (MM)/DCC
45	3 13	1 3 4 6		fx (MM)/DCC
46	3 14	2 3 4 6		fx (MM)/DCC
47	3 15	1 2 3 4 6		fx (MM)/DCC
48	3 16	5 6		fx (MM)/DCC
49	4 1	1 5 6		fx (MM)/DCC
50	4 2	2 5 6		fx (MM)/DCC



		 10 (0/1)										
51	4 3	1 2			5 6							fx (MM)/DCC
52	4 4			3	5 6							fx (MM)/DCC
53	4 5	1		3	5 6							fx (MM)/DCC
54	4 6		2 3		5 6							fx (MM)/DCC
55	4 7	1 2 3			5 6							fx (MM)/DCC
56	4 8				4 5 6							fx (MM)/DCC
57	4 9	1			4 5 6							fx (MM)/DCC
58	4 10		2		4 5 6							fx (MM)/DCC
59	4 11	1 2			4 5 6							fx (MM)/DCC
60	4 12			3 4 5 6								fx (MM)/DCC
61	4 13	1		3 4 5 6								fx (MM)/DCC
62	4 14		2 3 4 5 6									fx (MM)/DCC
63	4 15	1 2 3 4 5 6										fx (MM)/DCC
64	4 16						7					fx (MM)/DCC
65	5 1 1						7					fx (MM)/DCC
66	5 2		2				7					fx (MM)/DCC
67	5 3	1 2					7					fx (MM)/DCC
68	5 4			3			7					fx (MM)/DCC
69	5 5	1		3			7					fx (MM)/DCC
70	5 6		2 3				7					fx (MM)/DCC
71	5 7	1 2 3					7					fx (MM)/DCC
72	5 8				4		7					fx (MM)/DCC
73	5 9	1			4		7					fx (MM)/DCC
74	5 10		2		4		7					fx (MM)/DCC
75	5 11	1 2			4		7					fx (MM)/DCC



		 10 (0/1)										
76	5 12			3 4			7					fx (MM)/DCC
77	5 13	1		3 4			7					fx (MM)/DCC
78	5 14		2 3 4				7					fx (MM)/DCC
79	5 15	1 2 3 4					7					fx (MM)/DCC
80	5 16					5	7					fx (MM)/DCC
81	6 1 1					5	7					fx (MM)/DCC
82	6 2		2			5	7					fx (MM)/DCC
83	6 3	1 2				5	7					fx (MM)/DCC
84	6 4			3 5 7								fx (MM)/DCC
85	6 5	1		3 5 7								fx (MM)/DCC
86	6 6		2 3 5 7									fx (MM)/DCC
87	6 7	1 2 3 5 7										fx (MM)/DCC
88	6 8				4 5 7							fx (MM)/DCC
89	6 9	1			4 5 7							fx (MM)/DCC
90	6 10		2 4 5 7									fx (MM)/DCC
91	6 11	1 2 4 5 7										fx (MM)/DCC
92	6 12			3 4 5 7								fx (MM)/DCC
93	6 13	1		3 4 5 7								fx (MM)/DCC
94	6 14		2 3 4 5 7									fx (MM)/DCC
95	6 15	1 2 3 4 5 7										fx (MM)/DCC
96	6 16					6 7						fx (MM)/DCC
97	7 1 1					6 7						fx (MM)/DCC
98	7 2		2			6 7						fx (MM)/DCC
99	7 3	1 2				6 7						fx (MM)/DCC
100	7 4			3		6 7						fx (MM)/DCC



			10 (0/1)		
101	7 5	1	3	6 7	fx (MM)/DCC
102	7 6		2 3	6 7	fx (MM)/DCC
103	7 7	1 2 3		6 7	fx (MM)/DCC
104	7 8		4	6 7	fx (MM)/DCC
105	7 9	1	4	6 7	fx (MM)/DCC
106	7 10		2	4 6 7	fx (MM)/DCC
107	7 11	1 2	4	6 7	fx (MM)/DCC
108	7 12		3 4	6 7	fx (MM)/DCC
109	7 13	1	3 4	6 7	fx (MM)/DCC
110	7 14		2 3 4	6 7	fx (MM)/DCC
111	7 15	1 2 3 4		6 7	fx (MM)/DCC
112	7 16			5 6 7	fx (MM)/DCC
113	8 1	1		5 6 7	fx (MM)/DCC
114	8 2		2	5 6 7	fx (MM)/DCC
115	8 3	1 2		5 6 7	fx (MM)/DCC
116	8 4		3	5 6 7	fx (MM)/DCC
117	8 5	1	3	5 6 7	fx (MM)/DCC
118	8 6		2 3	5 6 7	fx (MM)/DCC
119	8 7	1 2 3		5 6 7	fx (MM)/DCC
120	8 8		4	5 6 7	fx (MM)/DCC
121	8 9	1		4 5 6 7	fx (MM)/DCC
122	8 10		2	4 5 6 7	fx (MM)/DCC
123	8 11	1 2		4 5 6 7	fx (MM)/DCC
124	8 12		3 4	5 6 7	fx (MM)/DCC
125	8 13	1	3 4	5 6 7	fx (MM)/DCC



			10 (0/1)			
126	8 14		2 3 4	5 6 7	fx (MM)/DCC	
127	8 15	1 2 3 4	5 6 7		fx (MM)/DCC	
128	8 16			8	fx (MM)/DCC	
129	9 1	1		8	fx (MM)/DCC	
130	9 2		2	8	fx (MM)/DCC	
131	9 3	1 2		8	fx (MM)/DCC	
132	9 4		3	8	fx (MM)/DCC	
133	9 5	1	3	8	fx (MM)/DCC	
134	9 6		2 3	8	fx (MM)/DCC	
135	9 7	1 2 3		8	fx (MM)/DCC	
136	9 8			4	8	fx (MM)/DCC
137	9 9	1		4	8	fx (MM)/DCC
138	9 10		2	4	8	fx (MM)/DCC
139	9 11	1 2		4	8	fx (MM)/DCC
140	9 12		3 4	8	fx (MM)/DCC	
141	9 13	1	3 4	8	fx (MM)/DCC	
142	9 14		2 3 4	8	fx (MM)/DCC	
143	9 15	1 2 3 4		8	fx (MM)/DCC	
144	9 16			5	8	fx (MM)/DCC
145	10 1	1		5	8	fx (MM)/DCC
146	10 2		2	5	8	fx (MM)/DCC
147	10 3	1 2		5	8	fx (MM)/DCC
148	10 4		3	5	8	fx (MM)/DCC
149	10 5	1	3	5	8	fx (MM)/DCC
150	10 6		2 3	5	8	fx (MM)/DCC



												10 (0/1)
151	10 7	1	2	3	5	8	fx (MM)/DCC					
152	10 8			4	5	8	fx (MM)/DCC					
153	10 9	1		4	5	8	fx (MM)/DCC					
154	10 10		2	4	5	8	fx (MM)/DCC					
155	10 11	1	2	4	5	8	fx (MM)/DCC					
156	10 12			3	4	5	8	fx (MM)/DCC				
157	10 13	1		3	4	5	8	fx (MM)/DCC				
158	10 14		2	3	4	5	8	fx (MM)/DCC				
159	10 15	1	2	3	4	5	8	fx (MM)/DCC				
160	10 16					6	8	fx (MM)/DCC				
161	11 1	1				6	8	fx (MM)/DCC				
162	11 2		2			6	8	fx (MM)/DCC				
163	11 3	1	2			6	8	fx (MM)/DCC				
164	11 4			3		6	8	fx (MM)/DCC				
165	11 5	1		3		6	8	fx (MM)/DCC				
166	11 6		2	3		6	8	fx (MM)/DCC				
167	11 7	1	2	3		6	8	fx (MM)/DCC				
168	11 8				4	6	8	fx (MM)/DCC				
169	11 9	1			4	6	8	fx (MM)/DCC				
170	11 10		2		4	6	8	fx (MM)/DCC				
171	11 11	1	2		4	6	8	fx (MM)/DCC				
172	11 12			3	4	6	8	fx (MM)/DCC				
173	11 13	1		3	4	6	8	fx (MM)/DCC				
174	11 14		2	3	4	6	8	fx (MM)/DCC				
175	11 15	1	2	3	4	6	8	fx (MM)/DCC				



												10 (0/1)
176	11 16					5	6	8	fx (MM)/DCC			
177	12 1	1				5	6	8	fx (MM)/DCC			
178	12 2		2			5	6	8	fx (MM)/DCC			
179	12 3	1	2			5	6	8	fx (MM)/DCC			
180	12 4			3		5	6	8	fx (MM)/DCC			
181	12 5	1		3		5	6	8	fx (MM)/DCC			
182	12 6		2	3		5	6	8	fx (MM)/DCC			
183	12 7	1	2	3		5	6	8	fx (MM)/DCC			
184	12 8				4	5	6	8	fx (MM)/DCC			
185	12 9	1			4	5	6	8	fx (MM)/DCC			
186	12 10		2		4	5	6	8	fx (MM)/DCC			
187	12 11	1	2		4	5	6	8	fx (MM)/DCC			
188	12 12			3	4	5	6	8	fx (MM)/DCC			
189	12 13	1		3	4	5	6	8	fx (MM)/DCC			
190	12 14		2	3	4	5	6	8	fx (MM)/DCC			
191	12 15	1	2	3	4	5	6	8	fx (MM)/DCC			
192	12 16						7	8	fx (MM)/DCC			
193	13 1	1					7	8	fx (MM)/DCC			
194	13 2		2				7	8	fx (MM)/DCC			
195	13 3	1	2				7	8	fx (MM)/DCC			
196	13 4			3			7	8	fx (MM)/DCC			
197	13 5	1		3			7	8	fx (MM)/DCC			
198	13 6		2	3			7	8	fx (MM)/DCC			
199	13 7	1	2	3			7	8	fx (MM)/DCC			
200	13 8				4		7	8	fx (MM)/DCC			



			10 (0/1)					
201	13 9	1		4		7 8	fx (MM)/DCC	
202	13 10		2	4		7 8	fx (MM)/DCC	
203	13 11	1 2		4		7 8	fx (MM)/DCC	
204	13 12			3 4		7 8	fx (MM)/DCC	
205	13 13	1		3 4		7 8	fx (MM)/DCC	
206	13 14		2 3 4			7 8	fx (MM)/DCC	
207	13 15	1 2 3 4				7 8	fx (MM)/DCC	
208	13 16			5		7 8	fx (MM)/DCC	
209	14 1	1		5		7 8	fx (MM)/DCC	
210	14 2		2	5		7 8	fx (MM)/DCC	
211	14 3	1 2		5		7 8	fx (MM)/DCC	
212	14 4			3 5		7 8	fx (MM)/DCC	
213	14 5	1		3 5		7 8	fx (MM)/DCC	
214	14 6		2 3 5			7 8	fx (MM)/DCC	
215	14 7	1 2 3 5				7 8	fx (MM)/DCC	
216	14 8			4 5 7 8			fx (MM)/DCC	
217	14 9	1		4 5 7 8			fx (MM)/DCC	
218	14 10		2	4 5 7 8			fx (MM)/DCC	
219	14 11	1 2		4 5 7 8			fx (MM)/DCC	
220	14 12			3 4 5 7 8			fx (MM)/DCC	
221	14 13	1		3 4 5 7 8			fx (MM)/DCC	
222	14 14		2 3 4 5 7 8				fx (MM)/DCC	
223	14 15	1 2 3 4 5 7 8					fx (MM)/DCC	
224	14 16				6 7 8		fx (MM)/DCC	
225	15 1	1			6 7 8		fx (MM)/DCC	
226	15 2		2		6 7 8		fx (MM)/DCC	



			10 (0/1)					
227	15 3	1 2			6 7 8		fx (MM)/DCC	
228	15 4		3		6 7 8		fx (MM)/DCC	
229	15 5	1 3			6 7 8		fx (MM)/DCC	
230	15 6		2 3		6 7 8		fx (MM)/DCC	
231	15 7	1 2 3			6 7 8		fx (MM)/DCC	
232	15 8			4	6 7 8		fx (MM)/DCC	
233	15 9	1		4	6 7 8		fx (MM)/DCC	
234	15 10		2	4	6 7 8		fx (MM)/DCC	
235	15 11	1 2		4	6 7 8		fx (MM)/DCC	
236	15 12			3 4	6 7 8		fx (MM)/DCC	
237	15 13	1 3 4			6 7 8		fx (MM)/DCC	
238	15 14		2 3 4		6 7 8		fx (MM)/DCC	
239	15 15	1 2 3 4			6 7 8		fx (MM)/DCC	
240	15 16				5 6 7 8		fx (MM)/DCC	
241	16 1	1			5 6 7 8		fx (MM)/DCC	
242	16 2		2		5 6 7 8		fx (MM)/DCC	
243	16 3	1 2			5 6 7 8		fx (MM)/DCC	
244	16 4			3	5 6 7 8		fx (MM)/DCC	
245	16 5	1 3			5 6 7 8		fx (MM)/DCC	
246	16 6		2 3		5 6 7 8		fx (MM)/DCC	
247	16 7	1 2 3			5 6 7 8		fx (MM)/DCC	
248	16 8			4	5 6 7 8		fx (MM)/DCC	
249	16 9	1		4	5 6 7 8		fx (MM)/DCC	
250	16 10		2	4	5 6 7 8		fx (MM)/DCC	
251	16 11	1 2		4	5 6 7 8		fx (MM)/DCC	
252	16 12			3 4	5 6 7 8		fx (MM)/DCC	



			10 (0/1)								
253	16 13	1		3	4	5	6	7	8		fx (MM)/DCC
254	16 14		2	3	4	5	6	7	8		fx (MM)/DCC
255	16 15	1	2	3	4	5	6	7	8		fx (MM)/DCC
256	16 16								9		fx (MM)/DCC
257	17 1	1							9		fx (MM)/DCC
258	17 2		2						9		fx (MM)/DCC
259	17 3	1	2						9		fx (MM)/DCC
260	17 4			3					9		fx (MM)/DCC
261	17 5	1		3					9		fx (MM)/DCC
262	17 6		2	3					9		fx (MM)/DCC
263	17 7	1	2	3					9		fx (MM)/DCC
264	17 8				4				9		fx (MM)/DCC
265	17 9	1			4				9		fx (MM)/DCC
266	17 10		2		4				9		fx (MM)/DCC
267	17 11	1	2		4				9		fx (MM)/DCC
268	17 12			3	4				9		fx (MM)/DCC
269	17 13	1		3	4				9		fx (MM)/DCC
270	17 14		2	3	4				9		fx (MM)/DCC
271	17 15	1	2	3	4				9		fx (MM)/DCC
272	17 16					5			9		fx (MM)/DCC
273	18 1	1				5			9		fx (MM)/DCC
274	18 2		2			5			9		fx (MM)/DCC
275	18 3	1	2			5			9		fx (MM)/DCC
276	18 4			3		5			9		fx (MM)/DCC
277	18 5	1		3		5			9		fx (MM)/DCC
278	18 6		2	3		5			9		fx (MM)/DCC



			10 (0/1)								
279	18 7		1	2	3		5			9	fx (MM)/DCC
280	18 8					4	5			9	fx (MM)/DCC
281	18 9	1				4	5			9	fx (MM)/DCC
282	18 10		2			4	5			9	fx (MM)/DCC
283	18 11	1	2			4	5			9	fx (MM)/DCC
284	18 12			3	4	5				9	fx (MM)/DCC
285	18 13	1		3	4	5				9	fx (MM)/DCC
286	18 14		2	3	4	5				9	fx (MM)/DCC
287	18 15	1	2	3	4	5				9	fx (MM)/DCC
288	18 16						6			9	fx (MM)/DCC
289	19 1	1					6			9	fx (MM)/DCC
290	19 2		2				6			9	fx (MM)/DCC
291	19 3	1	2				6			9	fx (MM)/DCC
292	19 4			3			6			9	fx (MM)/DCC
293	19 5	1		3			6			9	fx (MM)/DCC
294	19 6		2	3			6			9	fx (MM)/DCC
295	19 7	1	2	3			6			9	fx (MM)/DCC
296	19 8				4		6			9	fx (MM)/DCC
297	19 9	1			4		6			9	fx (MM)/DCC
298	19 10		2		4		6			9	fx (MM)/DCC
299	19 11	1	2		4		6			9	fx (MM)/DCC
300	19 12			3	4		6			9	fx (MM)/DCC
301	19 13	1		3	4		6			9	fx (MM)/DCC
302	19 14		2	3	4		6			9	fx (MM)/DCC
303	19 15	1	2	3	4		6			9	fx (MM)/DCC
304	19 16					5	6			9	fx (MM)/DCC



												10 (0/1)
305	20	1	1			5	6			9	fx (MM)/DCC	
306	20	2		2		5	6			9	fx (MM)/DCC	
307	20	3	1	2		5	6			9	fx (MM)/DCC	
308	20	4			3	5	6			9	fx (MM)/DCC	
309	20	5	1		3	5	6			9	fx (MM)/DCC	
310	20	6		2	3	5	6			9	fx (MM)/DCC	
311	20	7	1	2	3	5	6			9	fx (MM)/DCC	
312	20	8				4	5	6		9	fx (MM)/DCC	
313	20	9	1			4	5	6		9	fx (MM)/DCC	
314	20	10		2		4	5	6		9	fx (MM)/DCC	
315	20	11	1	2		4	5	6		9	fx (MM)/DCC	
316	20	12			3	4	5	6		9	fx (MM)/DCC	
317	20	13	1		3	4	5	6		9	fx (MM)/DCC	
318	20	14		2	3	4	5	6		9	fx (MM)/DCC	
319	20	15	1	2	3	4	5	6		9	fx (MM)/DCC	
320	20	16						7		9	fx (MM)/DCC	
321	21	1	1					7		9	---/DCC	
322	21	2		2				7		9	---/DCC	
323	21	3	1	2				7		9	---/DCC	
324	21	4			3			7		9	---/DCC	
325	21	5	1		3			7		9	---/DCC	
326	21	6		2	3			7		9	---/DCC	
327	21	7	1	2	3			7		9	---/DCC	
328	21	8				4		7		9	---/DCC	
329	21	9	1			4		7		9	---/DCC	
330	21	10		2		4		7		9	---/DCC	



												10 (0/1)
331	21	11	1	2		4			7	9	---/DCC	
332	21	12			3	4			7	9	---/DCC	
333	21	13	1		3	4			7	9	---/DCC	
334	21	14		2	3	4			7	9	---/DCC	
335	21	15	1	2	3	4			7	9	---/DCC	
336	21	16					5		7	9	---/DCC	
337	22	1	1				5		7	9	---/DCC	
338	22	2		2			5		7	9	---/DCC	
339	22	3	1	2			5		7	9	---/DCC	
340	22	4			3		5		7	9	---/DCC	
341	22	5	1		3		5		7	9	---/DCC	
342	22	6		2	3		5		7	9	---/DCC	
343	22	7	1	2	3		5		7	9	---/DCC	
344	22	8				4	5		7	9	---/DCC	
345	22	9	1			4	5		7	9	---/DCC	
346	22	10		2		4	5		7	9	---/DCC	
347	22	11	1	2		4	5		7	9	---/DCC	
348	22	12			3	4	5		7	9	---/DCC	
349	22	13	1		3	4	5		7	9	---/DCC	
350	22	14		2	3	4	5		7	9	---/DCC	
351	22	15	1	2	3	4	5		7	9	---/DCC	
352	22	16					6	7	9	---	DCC	
353	23	1	1				6	7	9	---	DCC	
354	23	2		2			6	7	9	---	DCC	
355	23	3	1	2			6	7	9	---	DCC	
356	23	4			3		6	7	9	---	DCC	



		 10 (0/1)									
357	23 5	1		3		6 7	9				---/DCC
358	23 6		2 3			6 7	9				---/DCC
359	23 7	1 2 3				6 7	9				---/DCC
360	23 8			4		6 7	9				---/DCC
361	23 9	1		4		6 7	9				---/DCC
362	23 10		2	4		6 7	9				---/DCC
363	23 11	1 2		4		6 7	9				---/DCC
364	23 12			3 4		6 7	9				---/DCC
365	23 13	1		3 4		6 7	9				---/DCC
366	23 14		2 3 4			6 7	9				---/DCC
367	23 15	1 2 3 4				6 7	9				---/DCC
368	23 16				5 6 7	9					---/DCC
369	24 1	1			5 6 7	9					---/DCC
370	24 2		2		5 6 7	9					---/DCC
371	24 3	1 2			5 6 7	9					---/DCC
372	24 4			3	5 6 7	9					---/DCC
373	24 5	1		3	5 6 7	9					---/DCC
374	24 6		2 3		5 6 7	9					---/DCC
375	24 7	1 2 3			5 6 7	9					---/DCC
376	24 8			4 5 6 7	9						---/DCC
377	24 9	1		4 5 6 7	9						---/DCC
378	24 10		2	4 5 6 7	9						---/DCC
379	24 11	1 2		4 5 6 7	9						---/DCC
380	24 12			3 4 5 6 7	9						---/DCC
381	24 13	1		3 4 5 6 7	9						---/DCC
382	24 14		2 3 4 5 6 7	9							---/DCC

		 10 (0/1)									
383	24 15	1 2 3 4 5 6 7 9									---/DCC
384	24 16							8 9			---/DCC
385	25 1	1						8 9			---/DCC
386	25 2		2					8 9			---/DCC
387	25 3	1 2						8 9			---/DCC
388	25 4			3				8 9			---/DCC
389	25 5	1		3				8 9			---/DCC
390	25 6		2 3					8 9			---/DCC
391	25 7	1 2 3						8 9			---/DCC
392	25 8				4			8 9			---/DCC
393	25 9	1			4			8 9			---/DCC
394	25 10		2		4			8 9			---/DCC
395	25 11	1 2			4			8 9			---/DCC
396	25 12			3 4				8 9			---/DCC
397	25 13	1		3 4				8 9			---/DCC
398	25 14		2 3 4					8 9			---/DCC
399	25 15	1 2 3 4						8 9			---/DCC
400	25 16					5		8 9			---/DCC
401	26 1	1					5	8 9			---/DCC
402	26 2		2				5	8 9			---/DCC
403	26 3	1 2					5	8 9			---/DCC
404	26 4			3			5	8 9			---/DCC
405	26 5	1		3			5	8 9			---/DCC
406	26 6		2 3				5	8 9			---/DCC
407	26 7	1 2 3					5	8 9			---/DCC
408	26 8				4 5			8 9			---/DCC

			10 (0/1)				
409	26 9	1		4 5		8 9	---/DCC
410	26 10		2	4 5		8 9	---/DCC
411	26 11	1 2		4 5		8 9	---/DCC
412	26 12			3 4 5		8 9	---/DCC
413	26 13	1		3 4 5		8 9	---/DCC
414	26 14		2	3 4 5		8 9	---/DCC
415	26 15	1 2	3 4 5			8 9	---/DCC
416	26 16				6	8 9	---/DCC
417	27 1	1			6	8 9	---/DCC
418	27 2		2		6	8 9	---/DCC
419	27 3	1 2			6	8 9	---/DCC
420	27 4			3	6	8 9	---/DCC
421	27 5	1		3	6	8 9	---/DCC
422	27 6		2 3		6	8 9	---/DCC
423	27 7	1 2 3			6	8 9	---/DCC
424	27 8			4	6	8 9	---/DCC
425	27 9	1		4	6	8 9	---/DCC
426	27 10		2	4	6	8 9	---/DCC
427	27 11	1 2		4	6	8 9	---/DCC
428	27 12			3 4	6	8 9	---/DCC
429	27 13	1		3 4	6	8 9	---/DCC
430	27 14		2 3 4		6	8 9	---/DCC
431	27 15	1 2 3 4			6	8 9	---/DCC
432	27 16				5 6	8 9	---/DCC
433	28 1	1			5 6	8 9	---/DCC
434	28 2		2		5 6	8 9	---/DCC

			10 (0/1)				
435	28 3	1 2		5 6	8 9	---/DCC	
436	28 4		3	5 6	8 9	---/DCC	
437	28 5	1		3	5 6	8 9	---/DCC
438	28 6		2 3	5 6	8 9	---/DCC	
439	28 7	1 2 3		5 6	8 9	---/DCC	
440	28 8			4 5 6	8 9	---/DCC	
441	28 9	1		4 5 6	8 9	---/DCC	
442	28 10		2	4 5 6	8 9	---/DCC	
443	28 11	1 2		4 5 6	8 9	---/DCC	
444	28 12			3 4 5 6	8 9	---/DCC	
445	28 13	1		3 4 5 6	8 9	---/DCC	
446	28 14		2 3 4	5 6	8 9	---/DCC	
447	28 15	1 2 3 4	5 6		8 9	---/DCC	
448	28 16				7 8 9	---/DCC	
449	29 1	1			7 8 9	---/DCC	
450	29 2		2		7 8 9	---/DCC	
451	29 3	1 2			7 8 9	---/DCC	
452	29 4			3	7 8 9	---/DCC	
453	29 5	1		3	7 8 9	---/DCC	
454	29 6		2 3		7 8 9	---/DCC	
455	29 7	1 2 3			7 8 9	---/DCC	
456	29 8			4	7 8 9	---/DCC	
457	29 9	1		4	7 8 9	---/DCC	
458	29 10		2	4	7 8 9	---/DCC	
459	29 11	1 2		4	7 8 9	---/DCC	
460	29 12			3 4	7 8 9	---/DCC	

		 10 (0/1)									
461	29 13	1		3 4		7 8 9		---	/	DCC	
462	29 14		2 3 4			7 8 9		---	/	DCC	
463	29 15	1 2 3 4				7 8 9		---	/	DCC	
464	29 16				5	7 8 9		---	/	DCC	
465	30 1	1			5	7 8 9		---	/	DCC	
466	30 2		2		5	7 8 9		---	/	DCC	
467	30 3	1 2			5	7 8 9		---	/	DCC	
468	30 4			3	5	7 8 9		---	/	DCC	
469	30 5	1		3	5	7 8 9		---	/	DCC	
470	30 6		2 3		5	7 8 9		---	/	DCC	
471	30 7	1 2 3			5	7 8 9		---	/	DCC	
472	30 8				4 5	7 8 9		---	/	DCC	
473	30 9	1			4 5	7 8 9		---	/	DCC	
474	30 10		2		4 5	7 8 9		---	/	DCC	
475	30 11	1 2			4 5	7 8 9		---	/	DCC	
476	30 12			3 4 5		7 8 9		---	/	DCC	
477	30 13	1		3 4 5		7 8 9		---	/	DCC	
478	30 14		2 3 4 5			7 8 9		---	/	DCC	
479	30 15	1 2 3 4 5				7 8 9		---	/	DCC	
480	30 16				6	7 8 9		---	/	DCC	
481	31 1	1				6 7 8 9		---	/	DCC	
482	31 2		2			6 7 8 9		---	/	DCC	
483	31 3	1 2				6 7 8 9		---	/	DCC	
484	31 4			3		6 7 8 9		---	/	DCC	
485	31 5	1		3		6 7 8 9		---	/	DCC	

		 10 (0/1)									
486	31 6		2 3			6 7 8 9		---	/	DCC	
487	31 7	1 2 3				6 7 8 9		---	/	DCC	
488	31 8				4	6 7 8 9		---	/	DCC	
489	31 9	1			4	6 7 8 9		---	/	DCC	
490	31 10		2		4	6 7 8 9		---	/	DCC	
491	31 11	1 2			4	6 7 8 9		---	/	DCC	
492	31 12			3 4		6 7 8 9		---	/	DCC	
493	31 13	1		3 4		6 7 8 9		---	/	DCC	
494	31 14		2 3 4			6 7 8 9		---	/	DCC	
495	31 15	1 2 3 4				6 7 8 9		---	/	DCC	
496	31 16					5 6 7 8 9		---	/	DCC	
497	32 1	1				5 6 7 8 9		---	/	DCC	
498	32 2		2			5 6 7 8 9		---	/	DCC	
499	32 3	1 2				5 6 7 8 9		---	/	DCC	
500	32 4			3		5 6 7 8 9		---	/	DCC	
501	32 5	1		3		5 6 7 8 9		---	/	DCC	
502	32 6		2 3			5 6 7 8 9		---	/	DCC	
503	32 7	1 2 3				5 6 7 8 9		---	/	DCC	
504	32 8				4	5 6 7 8 9		---	/	DCC	
505	32 9	1			4	5 6 7 8 9		---	/	DCC	
506	32 10		2		4	5 6 7 8 9		---	/	DCC	
507	32 11	1 2			4	5 6 7 8 9		---	/	DCC	
508	32 12			3 4		5 6 7 8 9		---	/	DCC	
509	32 13	1		3 4		5 6 7 8 9		---	/	DCC	
510	32 14		2 3 4		5	6 7 8 9		---	/	DCC	
511	32 15	1 2 3 4 5			6	7 8 9		---	/	DCC	

Adressen größer 511 können nur im DCC Format ausgegeben werden und müssen mit der CV Programmierung über das Programmiergleis durchgeführt werden.

Addresses larger than 511 can only be assigned in the DCC format and must be done by programming a CV using the programming track.

Les adresses supérieures à 511 peuvent uniquement être éditées dans le format DCC et doivent être exécutées avec la programmation des CV via la voie de programmation.

Adressen groter dan 511 kunnen alleen in het DCC formaat gebruikt worden en moeten met de CV programmering via het programmeerspoor ingesteld worden.

Las direcciones superiores a 511 pueden mostrarse en el formato DCC y deben configurarse con la función Programación de CVs mediante la vía de programación.

Indirizzi maggiori di 511 possono essere assegnati solo nel formato DCC e si devono eseguire con la programmazione delle CV tramite il binario di programmazione.

Adresser överstigande 511 kan endast skrivas in i DCC-format och måste göras med CV-programmering med loket på programmeringspåret.

Adresser højere end 511 kan kun udtrykkes i DCC format og skal udføres med CV programmeringen via programmeringsporet.

Adresse notieren
Noting the address
Noter l'adresse
Adres noteren
Anotar la direcció
Annotate gli indirizzi
Notera adressen
Notér adresser

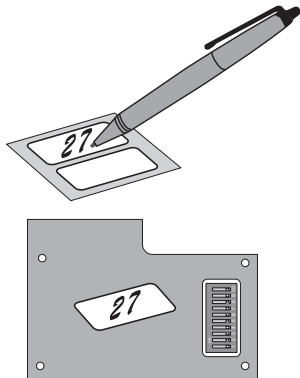



Points de collecte sur www.quefairedemesdechets.fr



Gebr. Märklin & Cie. GmbH
Stuttgarter Straße 55 - 57
73033 Göppingen
Germany
www.maerklin.com / service@maerklin.de

www.maerklin.com/en/imprint.html

393672/1024/Sm1Ef
Änderungen vorbehalten
© Gebr. Märklin & Cie. GmbH